

BYRNE

Dean® Edge Mount



* Image depicts a 3 window unit with 2 power and 1 USB in Black

OVERVIEW

Dean features a smooth faceplate, with a clean design that makes it an ideal power solution for any environment.

SPECIFICATIONS

* Image depicts a 5 window unit.

All dimensions remain the same except for X, which will change depending on the number of windows in the unit.

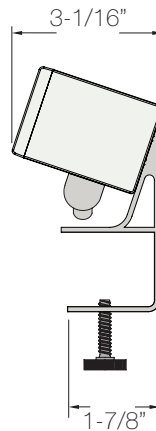
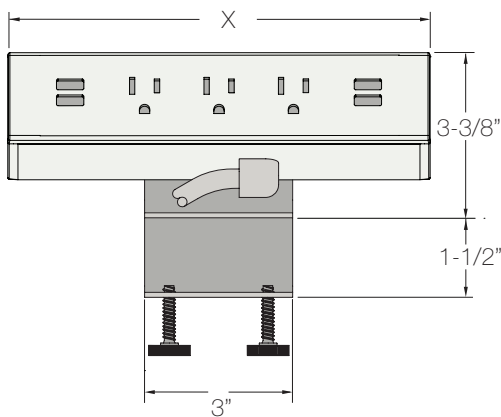

Dimensions

	X
2-Window	4"
3-Window	5-1/2"
4-Window	7"
5-Window	8 1/2"
6-Window	10"

Mounting Bracket

The bracket is mounted to the edge of a surface. The max thickness of the surface material is 1-1/2".

POWER ENTRY OPTIONS

UL LISTED

Corded
Hardwired
4-Trac
8-Trac

UL RECOGNIZED

Interlink
Interlink IQ

ETL LISTED

Interlink
Interlink IQ 2.0

CODES

NEW YORK

The Corded Dean can be used in the New York City, per the official NYC Electrical Code.

CHICAGO

The Corded Dean Edge Mount can be used on Listed freestanding furnishings in Chicago. Limitations apply. The Hardwired Dean Edge Mount must be used on all other furnishings in Chicago

CONFIGURATIONS AVAILABLE

Dean is available with 2, 3, 4, or 5 windows. We offer dual USB options with 2 Amps per port, 15 Amp power simplexes and Tamper Resistant simplexes (upon request) with this product. Below is a graphic representation of the power and data configurations available for this unit.

2 Window Unit



2 Power



1 USB-A, 1 Power



1 Open, 1 Power

6 Window Unit



1 Open, 1 USB-C 60W,
1 USB-A, 2 Power

3 Window Unit



3 Power



1 USB-A, 2 Power

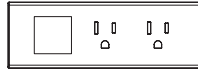

1 Open, 2 Power



1 USB-A+C, & 2 Power



1 USB-C 60W, 1 Power

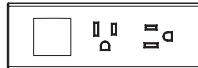

1 Open, 2 Power

4 Window Unit



2 USB & 2 Power



1 Open, 2 Power, & 1 USB



1 USB-A, 2 Power
& USB-C 18W,



1 Open, 2 Power,
& 1 USB-C 18W

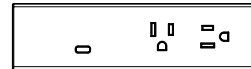

1 USB-C 60W, 2 Power

5 Window Unit

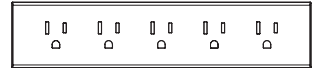

5 Power

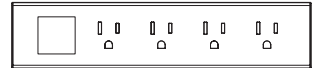

1 Open, 4 Power



2 USB-A, 3 Power



1 Open, 3 Power, 1 USB-A



1 USB-C 60W, 1 USB-A,
2 Power

Data Options



Cat6, Cat6 A, HDMI, VGA, Mini DisplayPort, Stereo Jack,
Passive USB-A, and Passive USB-C

NOTE: Factory install only for Mini DisplayPort

Tamper Resistant

Tamper Resistant units will be labeled with TR in the left hand corner of the faceplate.

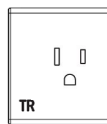

Discreet Cord

Dean's cord is now available exiting behind the product, upon request. Please note: this option is not available in all configurations. For more information, please contact Byrne.



FINISHES

Dean's housing is clear anodized aluminum. The color of the cord will default to white unless the faceplate and end caps are black, in which case it will default to a black cord. Dean is also available in many overbraided options.

Faceplate

